

MegaPulse

IMPULSE TESTER

1786

Instruction Manual

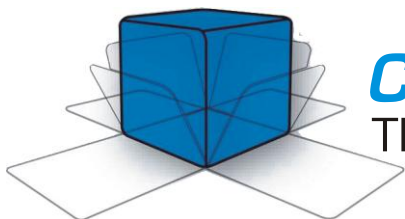

COMPLIANCE WEST USA

The blue box that tests. And tests.

Dear Customer:

Congratulations! Compliance West USA is proud to present you with your MegaPulse 1786 Impulse Tester. Your instrument features a groundbreaking logic-controlled circuit design and ergonomic front panel and represents the latest in high voltage impulse testing.

To fully appreciate all the features of your new instrument, we suggest that you take a few moments to review this manual. Compliance West USA stands by your instrument with a full one-year warranty. If the need arises, please don't hesitate to call on us.

Thank you for your trust and confidence.



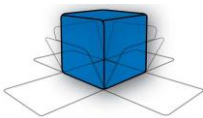
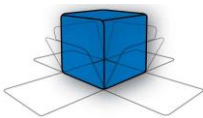

Table of Contents

An Introduction to Impulse Testing with the MegaPulse series tester	6
Safety Precautions	6
Test Personnel	6
Testing Area	6
Safety Techniques	7
Using the MegaPulse Impulse Tester	7
Introduction	10
Operation	11
Setting up your Tester	11
AC Line Voltage Requirements	11
Fuse Replacement	12
Front and Rear Panel Features	12
Figure 1. Controls, Indicators, Connectors – MegaPulse 1786 Front Panel	13
Table 1. Controls, Indicators, Connectors – MegaPulse 1786 Front Panel	15
Figure 2. Controls, Indicators, Connectors – MegaPulse 1786 Rear Panel	15
Table 2. Controls, Indicators, Connectors – MegaPulse 1786 Rear Panel	16
Initial Checkout Procedure	17
Testing	18
Technical Assistance	20
Maintenance	21
Introduction	21
Service Information	21
General Maintenance	21
Cleaning	21





Section 1

An Introduction to Impulse Testing with the MegaPulse series tester

The impulse test is designed to simulate impulse surges which occur in everyday life due to nearby lightning strikes, switching transients, and other high-frequency faults on the power distribution network. Impulse testing is the fundamental method for empirical verification of the adequacy of insulation. Other methods of ensuring adequate insulation (AC or DC Dielectric Withstand testing, measurement of over-surface creepage, through-air clearance, or distance-through-insulation) are all extrapolated from the results of impulse testing. The impulse test is performed to ensure that the insulation in question will be able to function properly when subjected to similar impulse surges in the field.

Safety Precautions

The impulse withstand test can generate voltages in excess of 6000 V peak at potentially lethal current levels. Currents of as little as 5 mA at 120 volts can cause death; the MegaPulse can deliver currents of more than 176 Amps peak for a very short time duration. The potential for serious injury or death exists and personnel should be aware when they conduct this test.

Test Personnel

Personnel require special training to conduct the impulse test. They should understand electrical fundamentals clearly, and be aware that high voltage is adept and creative at completing a path to ground. Instructions should include a warning against any metal jewelry. Operators should not allow others in the testing area, especially when tests are being conducted. Organization is to be stressed. The operator should keep the area free of unused leads and equipment.

Testing Area

The area used for conducting the impulse test should be as remote as possible from normal production line activities. Only personnel actually conducting the test should be allowed in the area, and it should be taped or roped off to preclude casual entry by other employees. In addition, the area should be marked "WARNING - HIGH VOLTAGE TESTING" or the equivalent to warn others of the nature of the testing taking place.

The bench being used should be non-conductive, and any exposed metal parts should be tied together and grounded. If a conductive surface must be used, it should be grounded.

Because of sparking during an impulse test failure, it is not safe to conduct impulse testing in combustible atmospheres.

It is imperative that a good ground be provided to the MegaPulse tester. Before connecting the equipment, ensure that the building wiring provides a low-resistance ground. If the MegaPulse tester is used on a high-resistance grounding circuit, dangerous high voltages may be present to the operator. In addition, the power to the Testing Area should be provided with an easily reached shutoff switch which can be actuated by personnel outside the Area if needed.



Safety Techniques

The high voltage circuit of the MegaPulse can be shut off at any time by turning OFF the rear power switch. Note that there are residual voltages inside the equipment that may take up to 5 minutes to bleed off to safe levels.

The MegaPulse tester is provided with a **VOLTAGE ADJUST** knob on the front panel. This should always be adjusted fully counterclockwise to the minimum position at the start of testing. In addition, this knob should be adjusted back to the minimum position at the completion of all testing.

The MegaPulse tester is provided with a **CHARGE** switch that is in the unarmed "Standby" setting when the tester is first turned ON. When the yellow **CHARGE** button is lit, the tester will not provide high voltage until the **CHARGE** Button and the **TRIGGER** Button have been pressed in order. To prevent inadvertent operation, the operator should be instructed not to press the **CHARGE** Button until the test is ready.

The MegaPulse tester has been designed for one-touch operation with the right hand. If possible, it should be set up to the left and in front of the equipment under test. The equipment under test should be connected to the MegaPulse tester and then left alone by the operator. After the operator is clear of the Tester and the equipment under test, the operator should turn the rear-panel power switch to ON, press the **CHARGE** Button, adjust the voltage to the desired level (as displayed on the front panel meter), then press the **TRIGGER** Button, with his right hand. This will allow the greatest separation between the operator and the test being conducted.

The MegaPulse tester is designed to bleed the high voltage away after the test has concluded. In order to ensure that any voltage present in the equipment being tested has been completely bled away, the operator should not unplug the equipment under test from the MegaPulse until the front panel meter reads a safe level (40 volts or less is generally considered a safe level). Pressing the **TRIGGER** button before disconnecting main power (or turning the equipment off) will ensure that the internal capacitors are discharged as much as possible.

Using the MegaPulse Impulse Tester

The impulse test involves high voltage and caution should be exercised when using the tester. The **RETURN** lead is referenced to building ground when properly connected. However, both the **OUTPUT** and **RETURN** leads must always be treated as Hazardous whenever the power switch of the MegaPulse is in the ON position.

The MegaPulse impulse tester generates the impulse waveform only; it does not determine Passing or Failing results. It is the operator's responsibility to monitor the output waveform and determine Passing or Failing results. In monitoring the impulse waveform, consider the following points:

The Impulse waveform is high voltage, and high frequency (short duration). Always ensure that the measuring instrument (usually an oscilloscope with a high-voltage probe) is rated for the voltage involved, and that the frequency response of the instrument and probe are capable of measuring the output waveform of the MegaPulse Impulse Tester. A measuring instrument or probe with a low frequency response will result in erroneous readings that could be mis-read.

Pressing the **POLARITY** switch on the front panel can change the polarity of the output waveform. The polarity is Normal when the **NOR** indicator is lit. In this case, the high voltage will appear on the **OUTPUT** as a positive pulse relative to the **RETURN** jack. When the polarity switch is in the Reverse position (**REV** indicator is lit), the high voltage will appear on the **OUTPUT** as a negative pulse relative to the **RETURN** jack. The polarity switch only operates when the **CHARGE** LED is lit, i.e. the output is not charged.



Note that the voltage meter may indicate that some residual voltage is present on the main storage capacitor, even when the tester is first turned ON. This is due to inherent charging of the internal capacitors. Pressing the **TRIGGER** switch will discharge the capacitors (be sure not to touch the output and return leads when pressing the trigger switch).

Note that the peak amplitude of the measured output waveform is proportional to the voltage that is read on the front panel of the MegaPulse, but it will always be somewhat lower. This is because the meter on the MegaPulse is measuring the voltage on the main impulse storage capacitor. This voltage will intentionally dissipate to some extent before reaching the output leads. Therefore, it is important to measure the peak amplitude of the output waveform, and adjust the output of the MegaPulse accordingly.

Determination of Passing and Failing results can prove difficult. To obtain the most accurate results, it is generally necessary to perform multiple impulse tests on a few different test samples (that have adequate insulation to pass the impulse test). Take note of the impulse waveshape, amplitude, and duration. Also note how much variance there is in the waveshape from test to test. Also (if possible), perform impulse testing on some test samples that are known to have inadequate (or damaged) insulation. Take note of the impulse waveshape, amplitude, and duration, when an insulation breakdown occurs.



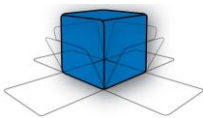

Section 2

Introduction

This manual contains complete operating, maintenance and calibration instructions for the Compliance West USA MegaPulse 1786 Impulse Tester.

- In case of trouble, the test can be immediately terminated at any time by turning the rear-panel power switch to the OFF position.
- Before the test can commence, the unit must be armed by pressing the **CHARGE** Button. The test will not begin until the **TRIGGER** Button is pushed.
- Operator instructions are printed on the rear panel for quick reference.
- Voltage is discharged by a resistor bank within the MegaPulse tester upon test completion. Discharge progress is shown on the front panel meter.

Your tester is warranted for a period of one year upon shipment of the instrument to the original purchaser.

Specifications

Specifications for the MegaPulse 1786 are listed in the table below and the component designations are shown in Figure 1.

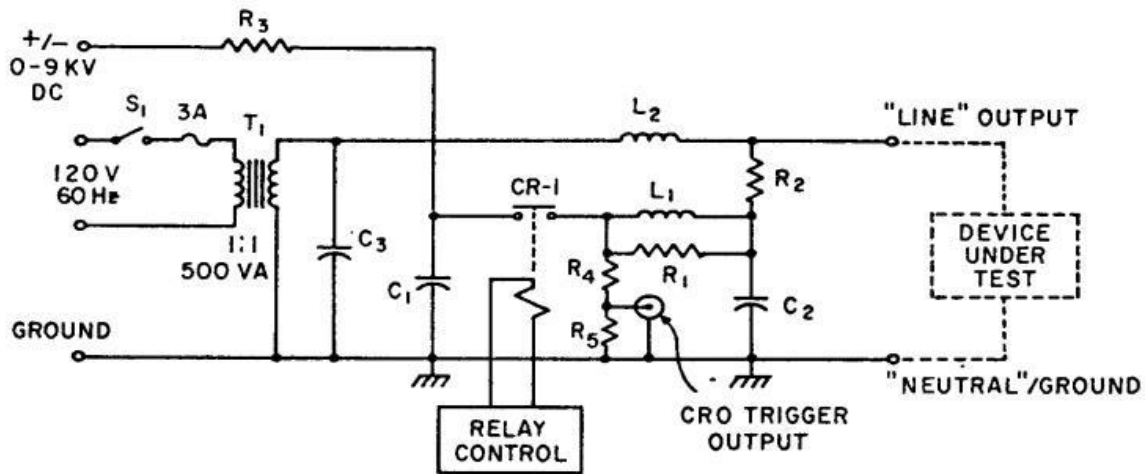

Model	Waveform	Max. Voltage	C1	C2	C3	R1	R2	R3	R4	L1	L2
1786	Oscillating	6000V	0.025 uF	0.01 uF	4 uF	22 ohm	12 ohm	1.3M ohm	47K ohm	14 uH	70 uH



Section 3

Operation

This section describes how to set up and make measurements with your Tester. We recommend that you read the entire section carefully so that you can use all of the features of your Tester.

Setting up your Tester

Your tester is shipped in a special protective container that should prevent damage to the instrument during shipping. Check the shipping order against the contents of the container and report any damage or short shipment to Compliance West USA. The container should include the following:

- The MegaPulse 1786 Tester
- Two high-voltage test leads, 1 red and 1 black
- An 18 AWG Line Power Cord
- This Instruction Manual
- Calibration certificate with waveform calibration pictures

If reshipment of the instrument is necessary, please use the original shipping container. If the original shipping container is not available, be sure that adequate protection is provided to prevent damage during shipment. We recommend that the instrument be surrounded by at least three inches of shock-absorbing material on all sides of the container.

Remove the tester from its container and place it on a test bench.

AC Line Voltage Requirements

AC line voltage requirements for your Tester are noted on the rear panel of the instrument. Do not connect the instrument to a different voltage source. The cord packaged with your MegaPulse Tester is for use in the United States. If another power cord must be used, the cord must be rated for the maximum current noted on the rear panel. It must also meet the requirements of IEC 227 or IEC 245, and mains cords that are certified or approved by any recognized national test house are regarded as meeting this requirement.



Fuse Replacement

There are (3) user-replaceable fuses located on the rear panel of the instrument. (F1) is located behind a door in the Power Inlet-Power Switch-Fuse Holder device. (F2) and (F3) are located on the rear panel. The fuse ratings are noted on the rear panel. Do not attempt to replace them with a fuse of any other rating.

Use the following procedure to replace the fuse F1:

1. Turn the power switch to the O or off position.
2. Unplug the instrument from the source of supply.
3. Remove the power inlet cord from the instrument.
4. Using a small screwdriver, pry open the fuse holder door.
5. Replace the fuse with a new one of the correct rating.
6. Replace the fuse holder door and power inlet cord.

Use the following procedure to replace fuses (F2) and (F3):

1. Turn the power switch to the O or off position.
2. Unplug the instrument from the source of supply.
3. Remove the fuse holder cover.
4. Replace the fuse with a new one of the correct rating.
5. Replace the fuse holder cover and power inlet cord.

Front and Rear Panel Features

Before using your Tester, take a few minutes to become familiar with the use of its controls, indicators and connectors. The front panel features of the MegaPulse are shown in Figure 1 and described in Table 1. The rear panel features of the MegaPulse are shown in Figure 2 and described in Table 2.



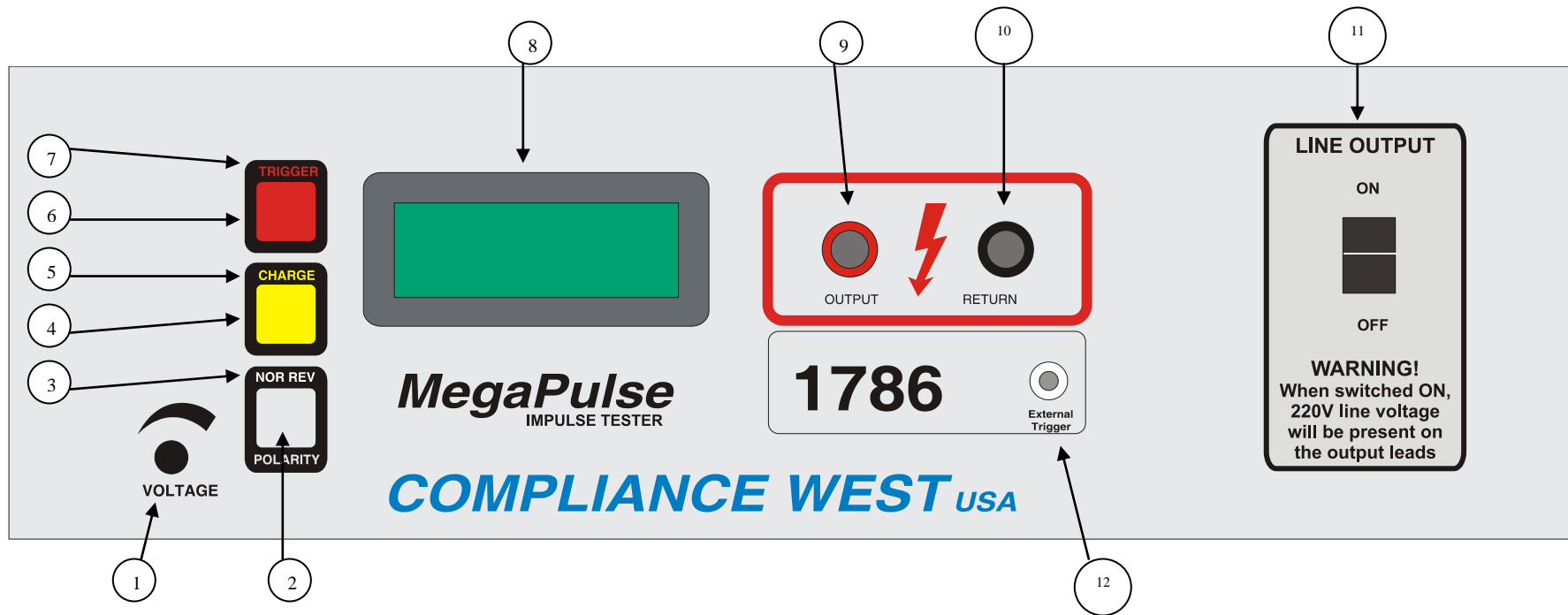
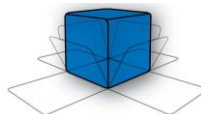
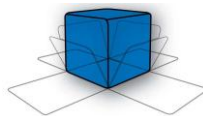

Figure 1. Controls, Indicators, Connectors – MegaPulse 1786 Front Panel



ITEM	NAME	FUNCTION
1	VOLTAGE Adjust Knob	Turn Clockwise to increase the output voltage after the CHARGE button has been pressed. Turn the knob fully counterclockwise (lowest voltage setting) before the start of each test, and after the end of each test.
2	POLARITY switch	The polarity switch only operates when the CHARGE indicator is lit, i.e. the output is not charged. The polarity of the output waveform can be changed by pressing the POLARITY switch on the front panel. Press this switch to toggle the output polarity from Normal to Reverse. The polarity is Normal when the NOR indicator is lit. In this case, the High Voltage will appear on the OUTPUT as a positive pulse relative to the RETURN jack. When the polarity switch is in the Reverse position (REV indicator is lit), the High voltage will appear on the OUTPUT as a negative pulse relative to the RETURN jack.
3	NOR REV indicator	Indicates the state of the Output Polarity switch. NOR indicate Normal position, REV indicates Reverse position.
4	CHARGE switch	Press this switch to begin charging the impulse storage capacitor. The CHARGE indicator will turn off after the CHARGE switch is pressed, and the TRIGGER indicator will turn on. The voltage on the capacitor will appear on the voltage meter, Item 8. This voltage will appear across the output leads when the TRIGGER switch is pressed. Note that the POLARITY switch is prevented from operating after the CHARGE switch has been pressed.
5	CHARGE indicator	This Yellow indicator is lit to show that pressing the CHARGE switch is the next logical step in a test sequence. Pressing the Charge switch causes the CHARGE indicator to go out.
6	TRIGGER switch	Press this switch (after pressing the CHARGE switch to charge the storage capacitor) to trigger the output impulse waveform. The impulse waveform will appear across the output leads.
7	TRIGGER indicator	This Red indicator is lit to show that pressing the TRIGGER switch is the next logical step in a test sequence. This indicator will turn on after the CHARGE switch is pressed, and will remain on until the TRIGGER switch is pressed. Pressing the TRIGGER switch causes the TRIGGER indicator to go out.
8	VOLTAGE meter	Displays the output voltage set point. This voltage is the theoretical open-circuit peak voltage that will appear across the output leads when the trigger button is pressed. The voltage reading will increase from zero to the voltage set point when the Charge switch is pressed. Note that the Voltage meter may indicate that some residual voltage is present on the main storage capacitor, even when the tester is first turned ON. This is due to inherent charging of the internal capacitors. Pressing the TRIGGER switch will discharge the capacitors (be sure not to touch the output and return leads when pressing the trigger switch). Note that the peak amplitude of the measured output waveform is proportional to the voltage that is read on the front panel of the MegaPulse, but it will always be somewhat lower. This is because the meter on the MegaPulse is measuring the voltage on the main impulse storage capacitor. This voltage will intentionally dissipate to some extent before reaching the output leads.
9	OUTPUT jack	The impulse waveform appears on the OUTPUT jack, referenced to the RETURN jack. When the POLARITY switch is in the Normal position (NOR indicator is lit) the output will be a positive pulse. When the POLARITY switch is in the Reverse position (REV indicator is lit) the output will be a negative pulse.
10	RETURN jack	This is the return for the impulse waveform. This jack is referenced to the chassis of the MegaPulse, and is referenced to earth ground as long as the MegaPulse is properly grounded. Even though this jack is referenced to ground, it should be treated as hazardous whenever the MegaPulse is turned ON.
11	LINE OUTPUT switch	When switched to the ON position, 220V line voltage will be present on the output leads.
12	EXTERNAL TRIGGER	The External Trigger Signal on the front panel is approximately 13 volts. In order to catch the correct signal the oscilloscope trigger level must be set to at least 10 volts.

Table 1. Controls, Indicators, Connectors – MegaPulse 1786 Front Panel



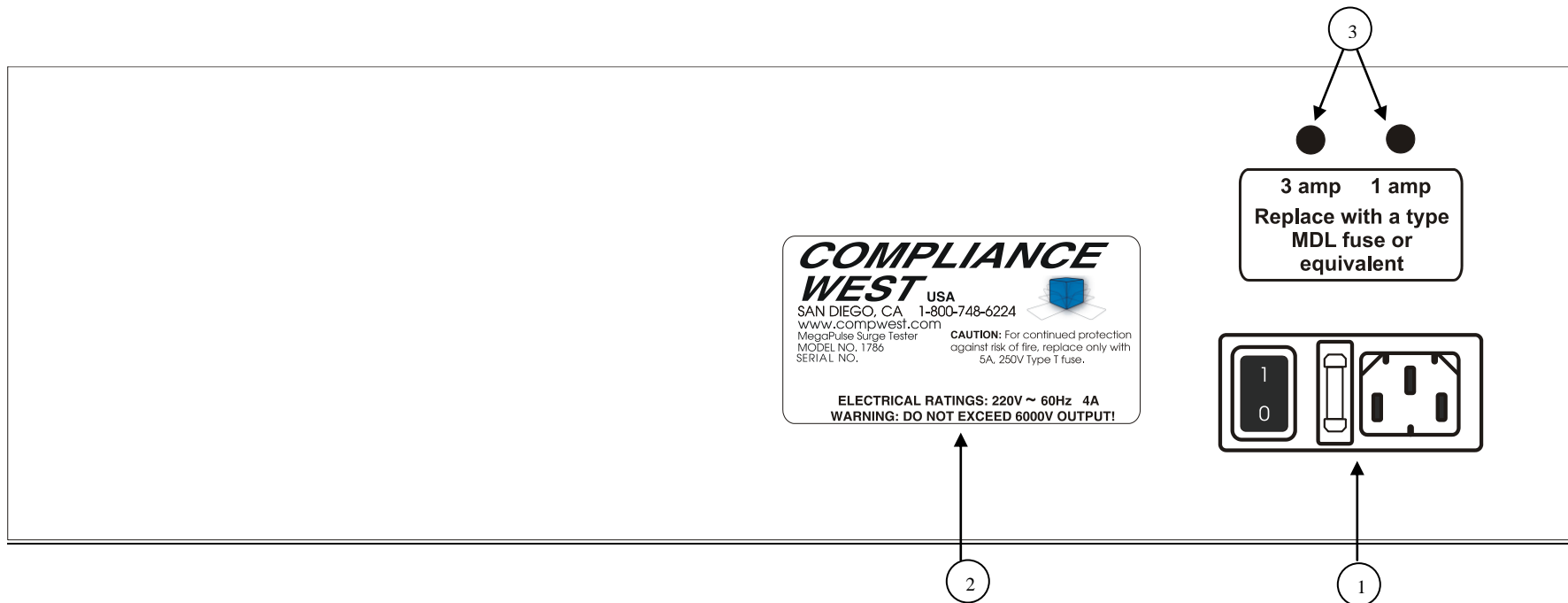
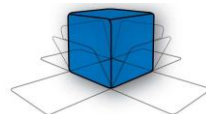
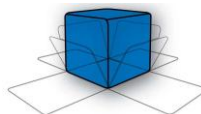

Figure 2. Controls, Indicators, Connectors – MegaPulse 1786 Rear Panel



ITEM NO.	NAME	FUNCTION
1	Appliance Inlet / Fuse holder / Power Switch	Use supplied cordset to connect Tester to appropriate source of supply. Fuse holder provides access for Fuse replacement, and the Power Switch is used to turn the tester ON and OFF.
2	Fuse replacement warning / Rating of supply	Specifies replacement fuse and required supply voltage.
3	External Fuses	Used to protect the internal transformer and logic. Replace with the specified type and value.

Table 2. Controls, Indicators, Connectors – MegaPulse 1786 Rear Panel



Initial Checkout Procedure

The following procedure will verify that the MegaPulse 1786 tester is working correctly. We recommend that this procedure be conducted periodically to ensure proper operation of the tester. A measuring instrument to monitor the output waveform is needed to conduct this procedure. Always ensure that the measuring instrument (usually an oscilloscope with a high-voltage probe) is rated for the voltage involved, and that the frequency response of the instrument and probe are capable of measuring the output waveform of the MegaPulse 1786 tester. A measuring instrument or probe with a low frequency response will result in erroneous readings that could be mis-read.

CAUTION

High voltage generated by the MegaPulse tester is exposed during this test. A risk of shock exists. Exercise care when using the MegaPulse tester.

1. Connect the tester to a proper source of supply using the included 18 AWG power supply cord. Make sure that the front panel **VOLTAGE** adjust knob is turned fully counterclockwise.
2. Plug the Output and Return test leads into the jacks on the front panel.
3. Connect the ends of the test leads to an appropriate measuring instrument (typically an oscilloscope with a high-voltage probe). Note that the **RETURN** lead is referenced to the chassis ground of the tester.
4. Turn the Tester on. Toggle the **POLARITY** switch if necessary so that the **NOR** indicator is lit.
5. Note that the Voltage meter may indicate that some residual voltage is present on the main storage capacitor, even when the tester is first turned ON. This is due to inherent charging of the internal capacitors. Pressing the **TRIGGER** switch will discharge the capacitors (be sure not to touch the output and return leads when pressing the trigger switch).
6. Push the yellow **CHARGE** button. Verify the red **TRIGGER** indicator is now lit.
7. Adjust the **VOLTAGE** knob so that the front panel LED display is reading a voltage that is suitable for the measuring instrument that is being used. Push the red **TRIGGER** button, and view the resulting impulse waveform on the measuring instrument.
8. Note that the peak amplitude of the measured output waveform is proportional to the voltage that is read on the front panel of the MegaPulse, but it will always be somewhat lower. This is because the meter on the MegaPulse is measuring the theoretical voltage on the main impulse storage capacitor. This voltage will intentionally dissipate to some extent before reaching the output leads.
9. Repeat steps 5 through 8, except this time toggle the **POLARITY** switch so that the **REV** indicator is lit. Note that the impulse waveform will now be a negative pulse, so it will probably be necessary to make adjustments to the measuring instrument to get a proper reading.
10. Adjust the **VOLTAGE** knob fully counterclockwise, to the minimum position. Turn the rear-panel power switch OFF.



Testing

This section describes how the MegaPulse 1786 tester is used to conduct a test. The test can be stopped immediately at any time by turning OFF the rear-panel power switch.

1. Connect the tester to a proper source of supply using the included 18 AWG power supply cord. Make sure that the front panel **VOLTAGE** adjust knob is turned fully counterclockwise.
2. Plug the Output and Return test leads into the jacks on the front panel.
3. Connect the ends of the test leads to the equipment under test.
4. Turn the Tester on. Toggle the **POLARITY** switch as needed so that the **NOR** or **REV** indicator is lit.
5. Note that the Voltage meter may indicate that some residual voltage is present on the main storage capacitor, even when the tester is first turned ON. This is due to inherent charging of the internal capacitors. Pressing the **TRIGGER** switch will discharge the capacitors (be sure not to touch the output and return leads when pressing the trigger switch).
6. Push the yellow **CHARGE** button. Verify the red **TRIGGER** indicator is now lit.
7. Adjust the **VOLTAGE** knob so that the front panel LED display is reading a voltage that is suitable for the measuring instrument that is being used. Push the red **TRIGGER** button, when the desired voltage is displayed on the front panel meter.
8. Note that the peak amplitude of the measured output waveform is proportional to the voltage that is read on the front panel of the MegaPulse, but it will always be somewhat lower. This is because the meter on the MegaPulse is measuring the theoretical voltage on the main impulse storage capacitor. This voltage will intentionally dissipate to some extent before reaching the output leads.

NOTE: According to the design specifications listed in the 1786 standard, the tester is calibrated at 3000 volts and will output the pulse as shown in the images supplied with the tester. By default of the 1786 standard the tester output is non linear. To output pulses at values different than 3000 volts it is required to use an oscilloscope to find the tester's meter value that will match the desired pulse.

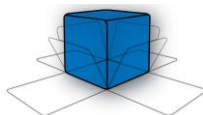

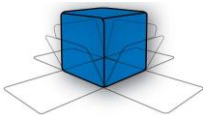

Section 4

Technical Assistance

For Technical Assistance

Phone: (800) 748-6224

Technical Assistance is available from Compliance West USA between the hours of 8:30 AM and 4:30 PM Pacific Time Monday through Friday.

Compliance West USA

2120 Jimmy Durante Blvd, Suite 118

Del Mar, CA., 92014

Phone: (858) 481-6454

FAX: (858) 481-8527

Technical information is also available on our web site at:
www.compwest.com

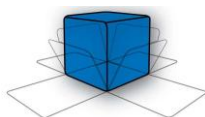

Section 5

Maintenance

WARNING

THESE SERVICE INSTRUCTIONS ARE FOR QUALIFIED PERSONNEL ONLY. TO AVOID ELECTRIC SHOCK, DO NOT PERFORM ANY SERVICING OTHER THAN THAT CONTAINED IN THE OPERATING INSTRUCTIONS UNLESS YOU ARE QUALIFIED TO DO SO.

Introduction

This section of the manual contains maintenance information for the MegaPulse 1786 tester. A 1-year calibration cycle is recommended to maintain the specifications given in Section 1.

Service Information

The MegaPulse tester is warranted to the original purchaser for a period of 1 year. This warranty does not cover problems due to misuse or neglect. Malfunctions which occur within the limits of the warranty will be corrected at no charge. Mail the instrument post paid to the manufacturer. Dated proof of purchase is required for all in-warranty repairs. The manufacturer is also available for calibration and / or repair of instruments that are beyond their warranty period. Contact the manufacturer for a cost quotation. Ship the instrument and your remittance according to the instructions given by the manufacturer.

General Maintenance

NOTE

To avoid contaminating the PWB with oil from your fingers, handle it by the edges or wear gloves. If the PWB becomes contaminated, refer to the cleaning procedures given later in this section.

NOTE

With the power cord replaced, the instrument is operational for service.

WARNING

Dangerous voltages exist when energized. Exercise extreme care when working on an energized circuit.

Cleaning

CAUTION

Do not use aromatic hydrocarbons or chlorinated solvents for cleaning. These solutions will react with the plastic materials used in the instrument.

Clean the front panel and case with a mild solution of detergent and a damp sponge. Clean dust from the PWB with clean, dry, low pressure (<20 psi) air.

